



ENAPART



93 S Railroad Avenue Unit C
Bergenfield NJ 07621 USA
www.enapart.com
sales@enapart.com



Via del Canneto 35,
Borgosatollo, Brescia - Italia
www.enapart.it
vendite@enapart.it



Barbaros Mah. Ihlamur Bul. Aĝaoĝlu
My Newwork No:3/15 Ataşehir / İstanbul
www.enapart.net
satis@enapart.net



PRIVADA 10 B SUR #3908 COL.
ANZUREZ, C.P. 72530, PUEBLA, PUE
www.enapart.com.mx
sales@enapart.com.mx



Friedrich-Ebert-Anlage 36, 60325
Frankfurt am Main, Germany
www.enapart.de
anfrage@enapart.de



4 boulevard Carnot, 95400
villiers-le-bel, Paris, France
www.enapart.fr
sales@enapart.fr



65049, ОДЕСА, ВУЛИЦЯ ІВАНА
ФРАНКА, БУДИНОК 55, ПОВЕРХ 3
www.enapart.com.ua
sales@enapart.com.ua



MUNICIPIUL BUCUREȘTI, SECTOR 3,
B-DUL BASARABIA, NR.250, CORP P+5
www.enapart.ro
sales@enapart.ro



〒584-0023 大阪府富田林市若松町
東2丁目2番16号
www.enapart.co.jp
sales@enapart.co.jp



PLAZA NUESTRA SEÑORA DE LAS
NIEVES 12 ,LOCAL ,50012,ZARAGOZA
www.enapart.es
ventas@enapart.es



Складова база „Онгъл“, Склад А2, п.к.
4006, гр. Пловдив, България
www.enapart.bg
sales@enapart.bg



3 Austin Mews, High Street, Hemel
Hempstead, HP1 3AF , United Kingdom
www.enapart.co.uk
sales@enapart.co.uk



32 07322B40

UNIVERSAL COLLECTION

Single-phase rectifiers for universal use

These half-wave and bridge rectifiers are ideal for installation in the connection boxes of medium power brake motors, brakes and solenoids.

Accessories include flying leads and a variety of mounting hardware so that installation on DIN rails is also possible. Encapsulated versions offer an extended operating temperature range. In case of additional DC side fast disconnection, the induction voltage induced by inductive loads is internally limited.

Technical specifications

Type	Rectification	Rated input voltage U_1 / VAC (+10%)	Max. output current at U_1 I / ADC	Output voltage U_2 / VDC	Design, temperature range ϑ_{13} / °C	DC side switching, disconnection voltage U_{0max} / V	Installation	Connections
32 07322B40	half-wave	0 ... 240 400 500	2.0 1.5 1.2	$U_2 = 0.445 \cdot U_1$	standard, non-encapsulated -25 ... 100	350	screws, accessories	6 terminals max. 2.5mm ² max. 0,4Nm
32 07323B40	bridge			$U_2 = 0.890 \cdot U_1$				
32 07332B40	half-wave			$U_2 = 0.445 \cdot U_1$	reinforced, encapsulated -40 ... 100			
32 07333B40	bridge			$U_2 = 0.890 \cdot U_1$				

CE

EMC Directive 2004/108/EEC:

Compliance with the following standards is confirmed:

- EN 50081-2 (Emission):
- EN 55011 (VDE 0875, part 11, 1992)
- Group 1, Class A conducted interference
- Group 1, Class B radiated interference
- EN 61000-6-2 (Immunity):
- EN 61000-4-3 (1997) severity level 3
- EN 61000-4-4 (1996) severity level 3
- EN 61000-4-5 (1996) severity level 3

Low Voltage Directive 2006/95/EEC:

Compliance with the following standards is confirmed: HD 625.1S1 (1996), (VDE 0110) insulation coordination, EN 60529 (1991) IP 54 external mounting

Machinery Directive 2006/42/EC: These products are considered components in the sense of Machinery Directive 2006/42/EC and must not be put into service until the machinery in which they are incorporated has been declared in conformity with the provisions of the EC Directives.

ROHS

The specified products comply with Directive 2002/95/EC (ROHS).

Accessories

Mounting rail clip

32 07322A00103

Set of mounting clips for 35mm mounting rail to EN50022.

1 set per rectifier

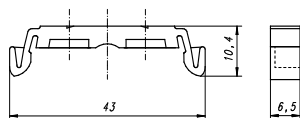

Figure similar to design

Adhesive pad:

32 07322A00104

Double-sided adhesive tape for installation on smooth surfaces. Dimensions 45 x 20 x 1mm³.

1 pad per rectifier

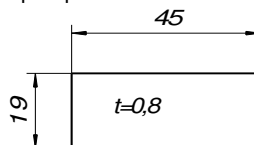

Flying leads:

32 17221A03004

Set of 2 flying leads with self-retaining fork cable lug M4, preferably for rectifier connection to motor terminal board.

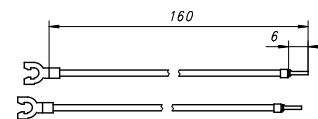

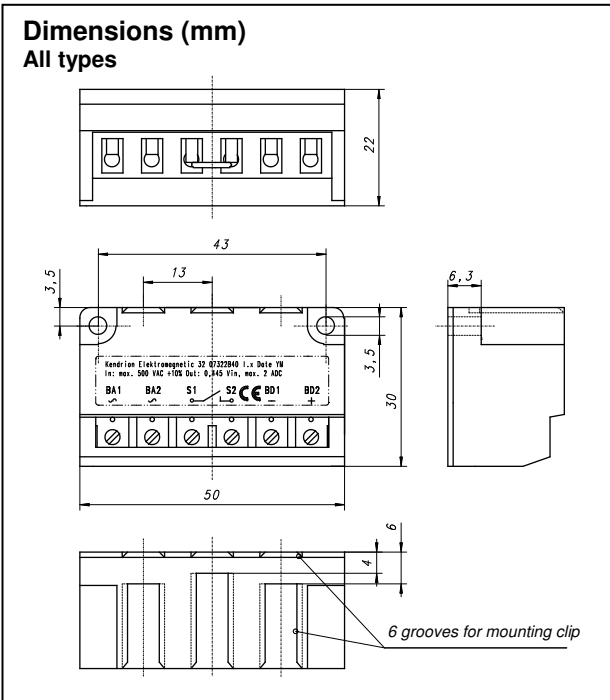
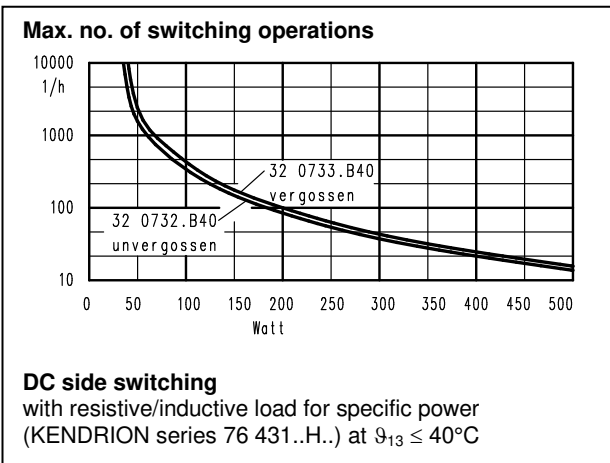

Connection and operation

Rectifiers with possible DC side switching are ideal for use with electromagnetic brakes of electric motors or with other electromagnetic components. The technical specifications depend on the connected loads and on their electric and mechanical properties. When electromagnetic brakes are operated in parallel with the motor without DC side switching, brake engagement may be significantly delayed after disconnection due to the generator function of the motor. The mechanical time constants during brake release or engagement must be taken into consideration. The maximum switching frequency of the rectifier merely

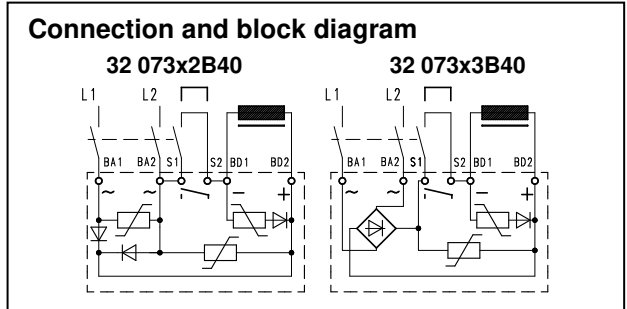
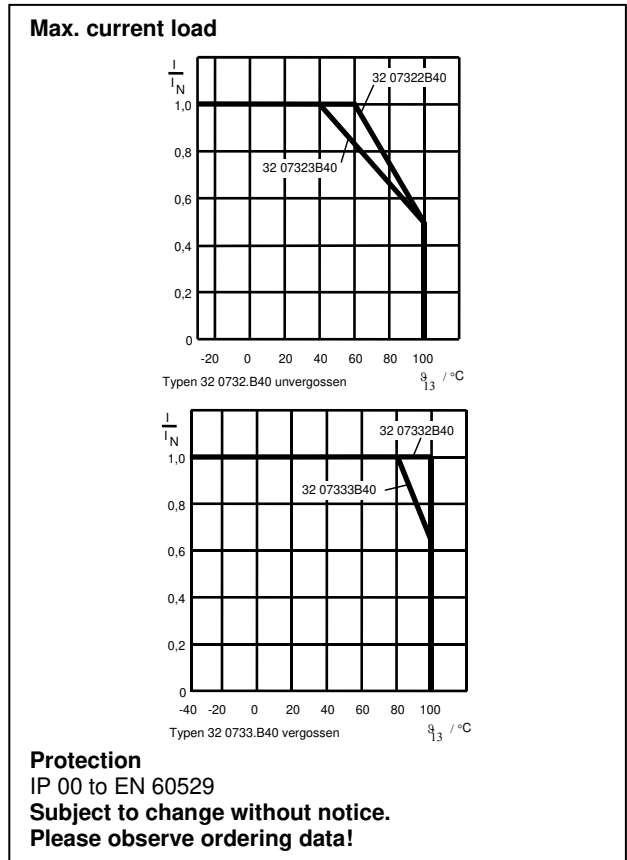
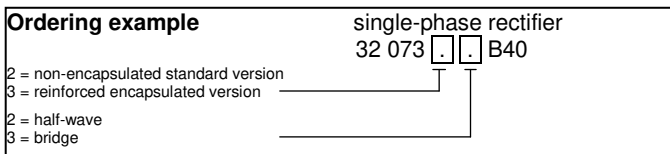

defines a limit value for the dissipated power that can be absorbed by the rectifier.

Attention!

Rectifier operation must take place in such a way that the connected load is not overloaded and that any use of the load other than its intended use is avoided. Check that the rectifier pinout is correct. Incorrect connection would cause irreversible damage to the rectifier. The rectifiers are not short-circuit proof. Output short-circuit to ground will destroy the rectifier.

Kendrion (Villingen) GmbH
Wilhelm-Binder-Straße 4-6
78048 Villingen-Schwenningen
Germany

Phone +49 7721 877 1417
Fax +49 7721 877 1462
E-Mail sales-ids@kendrion.com
www.kendrion.com